

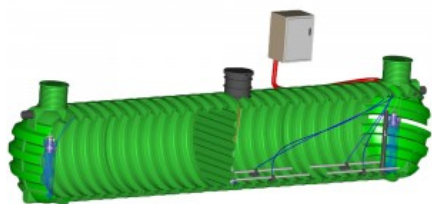





Impianti di trattamento acque - Impianto RoClean

Impianto RoClean 75 - 500 PU



Immagini

PU	Codice	immagine
75	6385	
100	6384	
1150	6386	
200	6387	
300	6388	



Dati tecnici

PU	Volume (L)	Codice	Dim. A x B x C (mm)	Coperchio (mm)	Max giorni di afflusso (m3/giorno)
75	30000	6385	6280x2310x2350	600	12
100	40000	6384	11320x2310x2350	600	15
150	50000	6386	13840x2310x2350	600	23
200	2x30000	6387	2x (8000x2310x2350)	600	30
300	2x40000	6388	2x (11320x2310x2350)	600	45
400	2x50000	6389	2x (13840x2310x2350)	600	60
500	3x40000	6390	2x (11320x2310x2350)	600	75

1x30000

1x (8800x2310x2
350)

Fotogalleria

